

O p e r a t i n g M a n u a l

Mini Call Shop Billing System

AX5000

Artech Technology Design Co., Ltd.
3F, No.8, Lane 263, Chong Yang Road, Nan Kang Dist., Taipei, Taiwan
Tel: 886-2-27852954 Fax: 886-2-27862783
Email: sales@artech.com.tw
www.artech.com.tw

Contents

Section 1 Product Overview	1
Section 2 Installation Instructions	2
Section 3 Usage Instructions	3
Section 4 Functionality Introduction	4
Section 5 Application Instructions	5
Section 6 Operating Specifications	6
6.1 Calling Rate Inquiry Mode	6
6.2 Post Pay Mode	6
6.3 Prepay Deposit Mode	7
6.4 User Inquiry Mode	9
6.5 Owner Mode	11
Section 7 Remote Updating Introduction	17
Section 8 Usage Warning	18

Section 1. Product Overview

AX5000 is a brand-new product mainly for telephone call billing solution researched by our company, due to its excellent appearance and powerful functionalities to bring much benefit for various users.

Product overview as below including keyboard, LCD display, LED indicator and IC card slot

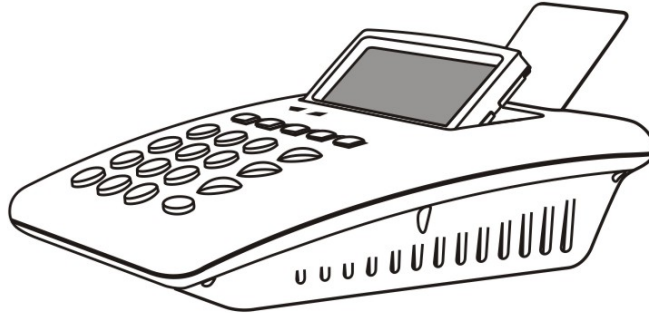

Product bottom view as below including memory card slot and programming Jack

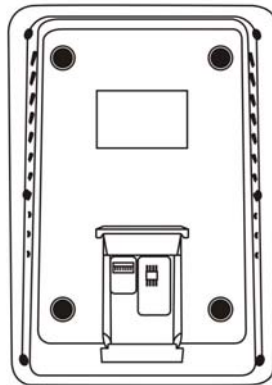

Product back view as below including 2 RJ11 Jack for Line and phone, DC power Jack and a switch; Switch ON/OFF usage: when set switch to ON status that means for normal working status, when set to OFF status used to validate update for new programming(after programming is done, set this switch to Off status and unplug power adapter at least half and hour, then go back to normal operating status)

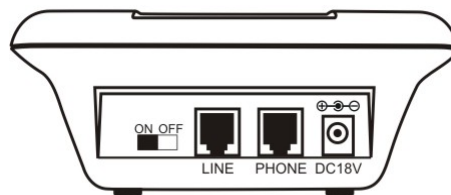

Section 2. Installation Instructions

Plug in 18V power adaptor and insert a battery inside the product, if the DC power is cut, the batter is special used for keeping its working status to remain data unchanged. AX5000 used RJ11 Jack is very convenient for all kinds of working environment and very easy to install.

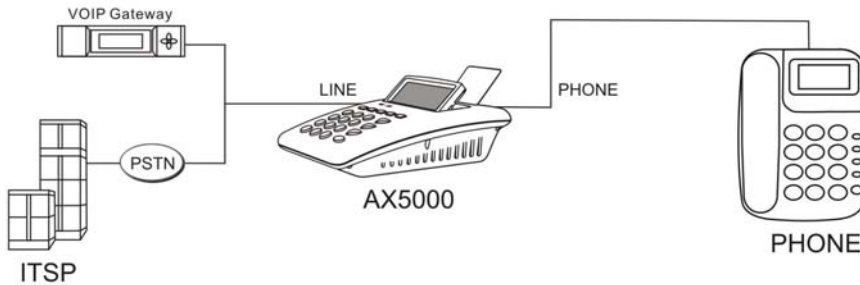

AX5000 normal working Installation procedures:

1. Fixed product to a suitable position
2. AX5000 Line terminal connect to Line (FXS)
3. AX5000 Phone terminal connect to telephone set
4. Plug DC 18V power adaptor to DC Jack of AX5000 product

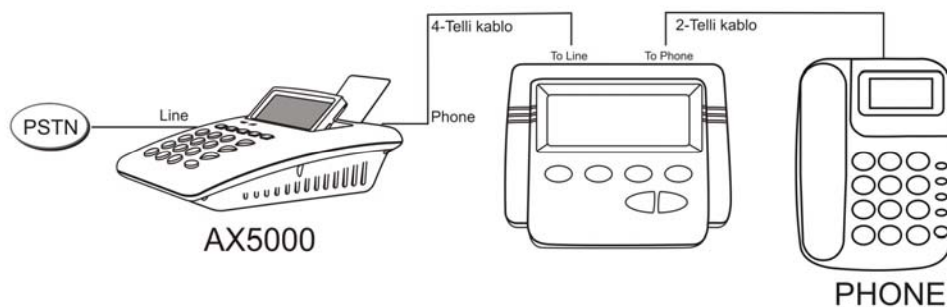

Connecting Billing Information Device between AX5000 and PHONE procedures:

1. Fixed product to a suitable position
2. AX5000 Line terminal connect to Line (FXS)
3. AX5000 Phone terminal connect to telephone set
4. Connect telephone to Billing Information Device phone Jack and connect AX5000 to Billing Information Device Line Jack via a 4-wires cable
5. Plug DC 18V power adaptor to DC Jack of AX5000 product

Additional: Please confirm connecting way like above diagram, then insert Flash Memory Card to AX5000 device and operate manually via IC card to set for normal user. If it is used for all ext. that it must be installed in front of the Line terminal, if it is only used for specified telephone that it can be

installed in front of telephone set,

PSTN - Ax5000- PBX- Telephone

As for normal user, AX5000 should be installed on line terminal in front of exchange, one Line combined with one AX5000 device. If user has ADSL device, then AX5000 must be installed between phone Jack and phone under ADSL router. If the user has MODEM device and telephone is installed Phone Jack on MODEM, then AX5000 must be installed in front of MODEM, that is to say Line to AX5000 first, then to MODEM and lastly to connect telephone set.

If there is ADSL modem the installation sequence should be:

PSTN - Ax5000- Modem - Telephone

PABX User Usage

Normal user installed AX5000 between Line and exchange (PBX). Telephone and ext. must be normal phone, the voltage range between Line and Phone terminal of exchange is: 24V~48V. When AX5000 is installed on Ext. of exchange, then it need set parameter 83 and 84 for dialing purpose. As for Key Phone System can not install AX5000 in front of Ext., it should be installed between Line and exchange.

Cautions:

If the DC power is cut under inserting battery inside product, then to plug DC power again will take 1 to 2 seconds to reset system, the current time on LCD display will be delayed 1 to 2 seconds, so we suggest you can reset clock time to a current time for exactly timing application!

Section 3. Usage Instructions

Making Phone Call

The dialing method are the same while making phone call whatever dialing landline, long distant call and international call as well as telecom station, you don't need to change its dialing method particularly. AX5000 system will detect automatically to justify its range which belongs to economized phone calls or others. AX5000 billing mode includes Prepay and Post pay modes.

Operational Notes:

1. Insert IC card and Flash Memory Card
2. LED Indication Instructions:
 - A. IC card Indicator: if IC card inserted or checked authorization failure, IC card indicator will light in Red color and break out 3 times Beep voice, else if IC card checked successful, then IC card indicator will be constant on Green color;
 - B. PHONE Indicator: On inquiry and setting modes, PHONE indicator will light in Red color; On Prepay and Post pay modes, PHONE will light in Green color; On dialing code mode will be flashing quickly in Green color; During talking status will be flashing slowly in Green color.
3. If no Flash Memory Card inside AX5000 device, then LCD will display NO DATA CARD.
4. On IP way or normal dialing way enter to Prepay or Post pay mode to pick up phone and dial code will get dial tone that stands making call successful until AX5000 received activated code will start billing, so please set activated codes for billing first before doing that(for details please refer to START BILLING

MODE). On PBX mode, if PBX Code is set, then it will get through Line first according to PBX mode before start billing by IP way.

Section 4. Functionality Introduction

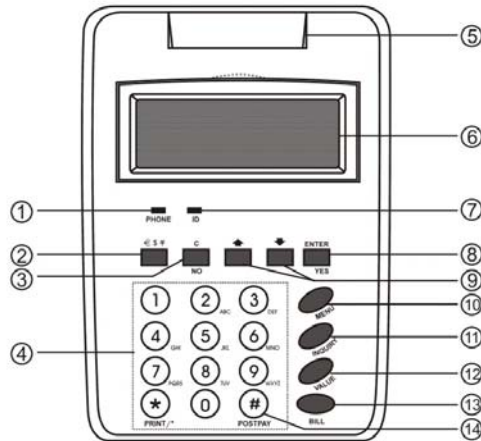

AX5000 device includes totally 21 buttons for various functionalities, the buttons are separated from 10 numerical keys and 11 functional keys, IC card slot, LCD display, Memory Card slot on bottom, phoning and IC card status indicator. Please note numerical keypad can not be used for dialing. It is used for parameter's settings. The functionality includes set contents of billing module, set expense rate, inquiry rate, inquiry calling rate, call log query, exchange rate query, set password, billing summary and set contents for Prepay as well Post pay modes and so on.

Each Logo upon device definition as follows:

1. Phone status indicator
2. Expenses rate exchange button. For instance, when customer check bill to press BILL button, suppose you are in American, if customer used RMB, then to press "¥\$" button and scroll up and down via UP and DOWN buttons to select your required expenses rate. Such as \$ --> ¥ stands RMB to exchange US dollars
3. C/NO: Used for clearing input data and return function.
4. Numerical Keypad: Used for number input
5. IC card slot
6. LCD display
7. IC card status indicator
8. Enter: Used for next step
9. UP \ DOWN: Used for scroll up and down for browsing (switchable key)
10. MENU: Used for starting settings of all functionalities on device
11. INQUIRY: Used for quickly inquiry rate
12. VALUE: Used for prepay mode
13. BILL: Used for billing summary
14. POSTPAY: Used for post pay mode

Section 5. Application Instructions

AX5000 Operating Mode Includes:

- (1). Calling rate inquiry mode
- (2). POST PAY mode
- (3). PREPAY DEPOSIT mode
- (4). User inquiry mode
- (5). Owner mode

When power-up will enter User inquiry mode first, by passed authorization can enter owner mode.

Before entering User inquiry and owner modes must meet below requirements:

- (1). FLASH card must be inserted (if no FLASH memory card will remind no card inside device)
- (2). IC card must pass its authorization (if no IC card can inquiry calling rate)

User Inquiry Mode:

- 1). Inquiry set contents
- 2). Inquiry talking information
- 3). OWNER MODE (passed authorization to User setting mode)

User Inquiry Mode >> Inquiry set contents includes:

- A. INQUIRY RATE (Default area code is: *****)
- B. SHOW CURRENCY EXCHANGE RATE
- C. BILL SUMMARY (inquiry billing info by time field)

User Inquiry Mode >> Inquiry talking information

- A. SHOW CALL LOG (phone call information)

Owner Mode Includes:

- (1). RATE MANEGEMENT (for rate setting)
- (2). DEFAULT RATE MANAGEMENT (for default rate setting)
- (3). DELETE CALL LOG (1. Clear one by one 2. Clear time field 3. Clear all)
- (4). CURRENCY EXCHANGE RATE SETTING
- (5). SET MAX. CREDIT FOR POST PAY (default credit: 0, set range: 0 ~ ∞)
- (6). SET RATE UNIT
- (7). SET DATE/TIME
- (8). SET DATE FORMAT
- (9). SET TIME FORMAT
- (10). CHANGE PASSWORD
- (11). PARAMETER SETTING (for Dialer)
- (12). ADJUST LCD CONTARAST (for LCD display)
- (13). START BILLING BY MODE (for activated codes setting of billing)
- (14). TAKE OUT DATA TO FLASH CARD (for taking out Eeprom data to flash card memory)
- (15). LOCAL CURRENCY NAME
- (16). EXIT OWNER MODE

Section 6. Operating Specifications

AX5000 operating mode includes calling rate inquiry mode, POST PAY mode, PREPAY DEPOSIT mode, User inquiry mode and Owner mode.

Cautions:

Except POST PAY and PREPAY DEPOSIT mode that dialing through Phone terminal of AX5000 and other operations on all modes via keyboard of AX5000!

6.1. Calling rate inquiry mode (User inquiry mode also include rate inquiry)

Plug DC power and remove IC card, LCD will display STANDBY INSERT IC CARD TO KEY IN VAULE and STANDBY PRESS INQUIRY TO CHECK RATE respectively

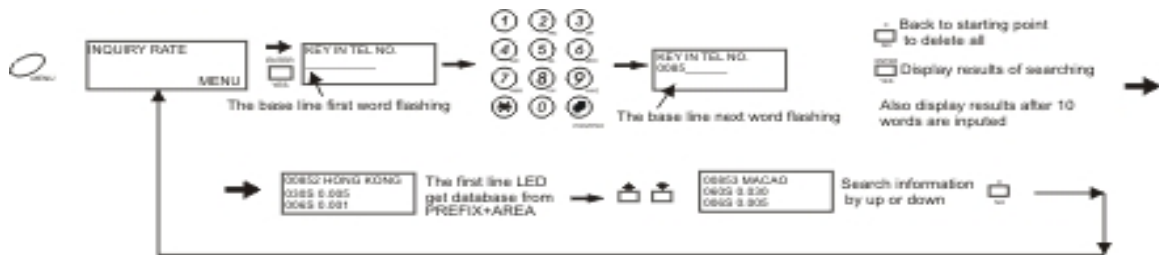

6.2. POST PAY mode

This feature is commonly used in most case that is to say after making calls to check billing.

Operation Procedures as follows:

1. On device to press  button to start post pay billing mode;

2. Then will show starting  messages;

3. To key in phone numbers  to make outgoing calls (Hook off status);

4. During talking status (Hook off)  will call billing info;

5. After hang up to end making calls(Hook on)  will show results for last call billing;

6. Before checking billing to make sure   ID card is inserted ok;

7. If ID card ok to press  button to check call billing;

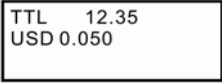

8. Then will show all call billing  messages;

9. To press  button for currency exchange rate;

10. Exchange rate  for US dollars;

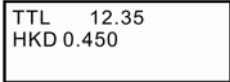
11. To press  button for next currency exchange rate;

12. Exchange rate  for HK dollars;

13. By Up and Down   buttons can enquiry all info on post pay;

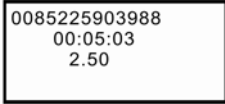
14. Then will show all messages  by this time on post pay billing mode;

6.3. PREPAY DEPOSIT mode

This feature means the user can prepay some money on call shop. It's very convenient for toll call billing on some emergency situations. After talking the user also can add more money under ID card is inserted. Meanwhile, if the prepay money is not enough during talking status, it will be automatically cut line.

Deposit money procedures as follows:

1. On device to press  button to start prepay mode;

2. Then will display prepay  to deposit money interface;



3. To key in billing amount numbers;



4. Then will display prepay amount on interface;



Back to starting point to delete all

Meanwhile can press this button to delete all if entering error;



Enter over

5. After entering ok to press button for confirmation;

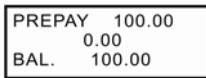

6. Then will display all info for the prepay results;

On Prepay mode call billing procedure as follows:



1. To key in phone numbers for outgoing calls (Hook off status);

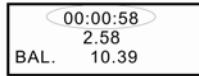

2. During talking status (Hook off) will show call info (includes talking time and charges as well as left money);

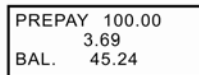

3. After hang up to end talking (Hook on) will show billing status;



4. Before checking billing to make sure ID card is inserted ok;

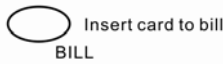

5. If ID card inserted ok to press button to sum up call billing;

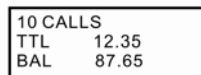

6. Then will show total expenses and residual money;



7. By Up and Down buttons can enquiry all call messages;

12:05AM 03-08
0085225903988
00:05:03
2.50

8. Then it will show all messages of outgoing calls on prepaid mode;

Cautions :

- 1). On Prepay and Post pay mode must insert IC card and Flash memory card;
- 2). If the power is disconnected during dialing process, billing display will last 1 minute (powered by battery) in order to finish billing for staff;
- 3). On owner mode, if the max credit is set to 100RMB, after billing exceed 100RMB, then AX5000 will cut line immediately, unless check out billing first so that can restart again;
- 4). On PREPAY DEPOSIT mode, if deposit 100RMB, once billing exceed 100RMB, AX5000 will also cut line immediately need to deposit again to proceed making calls.

6.4. User inquiry mode

(1). SHOW CALL LOG

ID CARD OK STAFF MODE → press MENU button → SHOW CALL LOG → press ENTER button → Display talking information (ex: phone number 123456 duration 00 : 00 : 03 charge 3.58 (local currency name)) → press UP and Down button can browse all phone information → press C/NO button → SHOW CALL LOG

(Cautions: Under power disconnecting of dialed information can be inquiry by this functionality!)

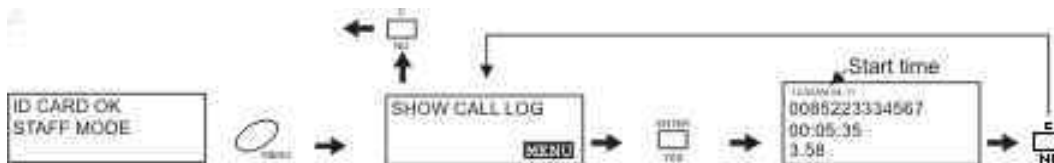

(2). INQUIRY RATE

SHOW CALL LOG → press MENU button → INQUIRY RATE → press ENTER → KEY IN TEL. NO. → Enter prefix of phone no. → Display rate information → press UP and DOWN button can browse consecutive rate information → press C/NO button → INQUIRY RATE

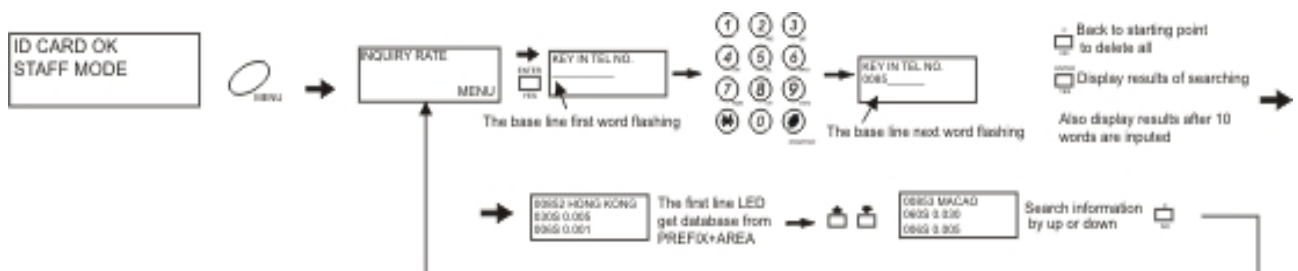

(3). SHOW CURRENCY EXCHANGE RATE

INQUIRY RATE → press MENU button → SHOW CURRENCY EXCHANGE RATE → display EXCHANGE RATE information (EXCHANGE RATE 1USA = 31.25 (local currency name)) → press UP and DOWN button can browse other exchange rate → press C/NO button → SHOW CURRENCY EXCHANGE RATE

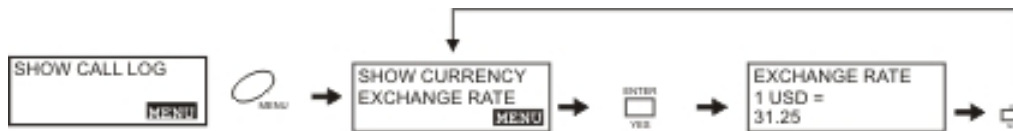

(4). BILL SUMMARY

SHOW CURRENCY EXCHANGE RATE → press MENU button → BILL SUMMARY → KEY IN PERIOD YYMMDD HH : MM YYMMDD HH : MM → Such as 06/07/08 12 : 00 06/07/08/14 : 30 → press ENTER button → If this time period had talking information, then will display bill summary info: 06/07/08 12 : 00 06/07/08/14 : 30 RMB 10.10 → press UP and DOWN can inquiry exactly how many calls made at that time → If no records will display 06/07/08 12 : 00 06/07/08/14 : 30 NO CALL LOG) → press C/NO button → BILL SUMMARY

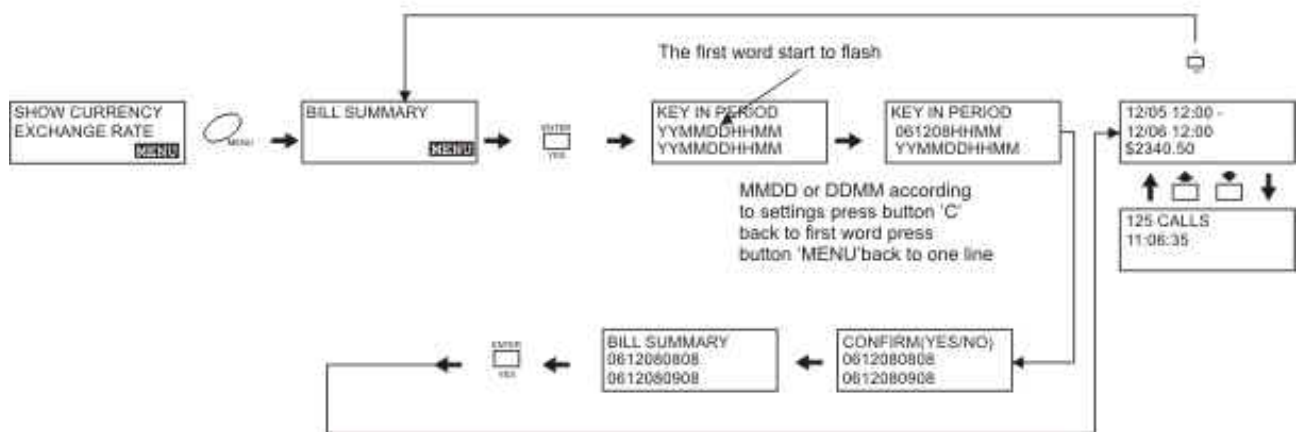

(5). OWNER MODE

BILL SUMMARY → press MENU button → OWNER MODE → press ENTER button → PASSWORD → If input 5 times with continuous errors on password checking, then it needs waiting 24 hours to recover initial input password status → if input password passed → OWNER MODE PLEASE REMEMBER TO EXIT LATER → press C/NO button → OWNER MODE

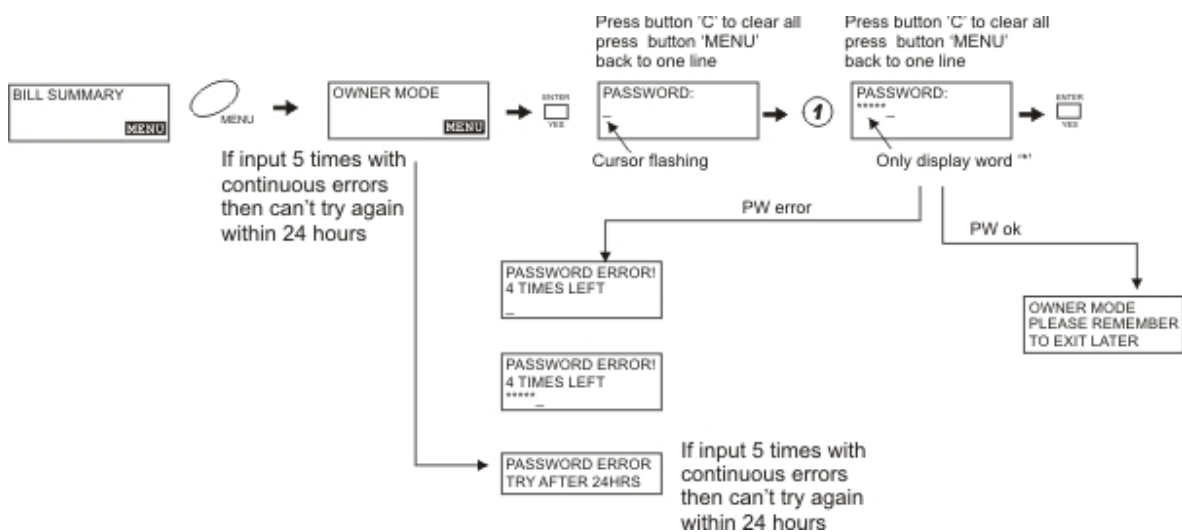

6.5. Owner mode (introduce AX5000 set manually)

Programming parameters to Flash Memory Card via AX5000 card writer (for more details please refer to Memory Card Writer (AW400) operating manual. However, you can also set on LCD display of AX5000 device as follows:

- (1). RATE MANEGEMENT
- (2). PARAMETER SETTING for DIALER
- (3). System parameter's setting includes :
 - A. CURRENCY EXCHANGE RATE SETTING
 - B. Activated codes setting (START BILLING MODE)
 - C. Local currency name setting
- (4). Read out talking record

AX5000 set mode by manual like following:

- (1). RATE MANEGEMENT

Cautions:

1. If manually set rate parameters must strictly observe the sequence, for example:
The sequence like this: Set area code 1 first, then to set 12, 123, 1234 or 12345678, etc.
Else if set 12345678 first, then set 1234567, or 12, 1, it is the wrong way for the sequence.
2. If set rate parameters automatically should be under software and card writer (AX400). Once this programming mode is used, please ignore the manual programming mode at this time.

A. RATE MANEGEMENT → press ENTER button → enter PREFIX mode, cursor position will remind to input RATE area (LCD display PREFIX cursor reminding) → enter area code (0449) → press ENTER button → enter name setting of area code (LCD display area code 050 AREA NAME : cursor reminds to input name of area code) → enter name of area code (BEIJING) → press ENTER button → enter billing way (LCD display 1. area code 0449 SAVE 2. time 000 (time unit) S (money) 0 (money unit) U (rate unit 1) 3. time 000 (time unit) S (money) 0 (money unit) U (rate unit 1)) After filled in one item to press DOWN button to fill parameters according to cursor reminding → Once parameters are filled done → cursor will shift to SAVE flashing → press ENTER button to save its settings → RATE MANEGEMENT

(Cautions: area code 0449 name of area code BEIJING time 010S rate 10YTL time 001S rate 1YTL; As for billing application → During talking status will start billing with 10 sec (10YTL), then will count billing as per 1 sec(1YTL))

B. RATE MANEGEMENT → press ENTER button → enter PREFIX mode, cursor position will remind to input RATE area (LCD display PREFIX cursor reminding) → enter area code (0449) → press ENTER button → LCD will display area code 0049 name of area code BEIJING 2 functional selections 1.EDIT 2.DEL → press 1 to restart to edit expense rate, press 2 to delete this expense rate → Then you can set by what you want → RATE MANEGEMENT

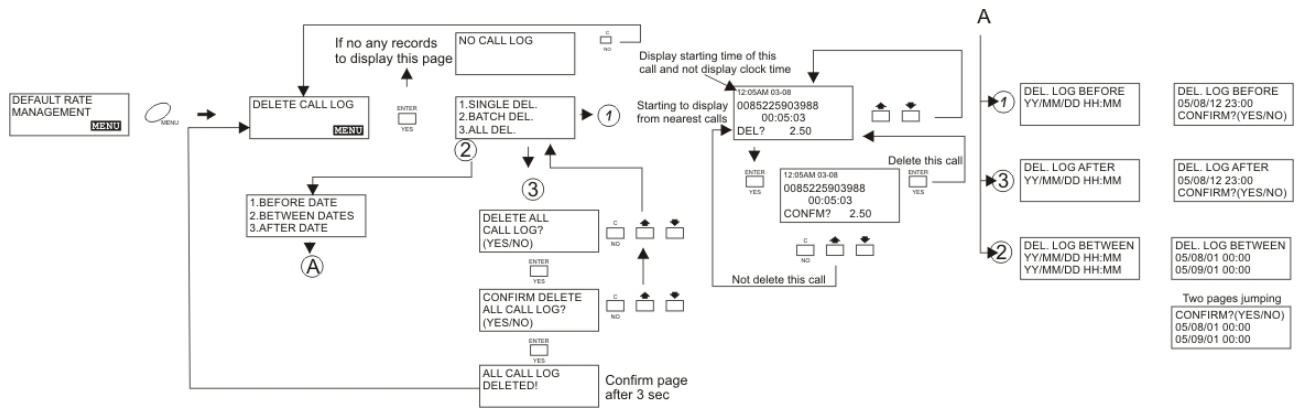

(4). CURRENCY EXCHANGE RATE SETTING

A. Rate exchange setting: DELETE CALL LOG → press MENU button → CURRENCY EXCHANGE RATE SETTING → press ENTER button → (If no exchange rate information will display: CURRENCY 1 NULL ADD? (YES/NO)) → press ENTER button → press C/NO → CURRENCY EXCHANGE RATE SETTING → press ENTER button → LCD display: CURRENCY 1 : – (cursor) RATE : RMB) → If set CURRENCY 1 : USA RATE : 8.01 RMB (local currency name)1USA = 8.01RMB) → CURRENCY 1 : USA (press DOWN button)RATE : 8.01 RMB → After setting done → CURRENCY 1 : USA) RATE : 8.01 RMB 1.SAVE(save) 2.CANCEL (return last time) → Enter 1 and saved → CURRENCY EXCHANGE RATE SETTING

B. Rate exchange edit: DELETE CALL LOG → press MENU button → CURRENCY EXCHANGE RATE SETTING → press ENTER button → (if have exchange rate information will display : CURRENCY 1 : USA RATE : 8.01 RMB (local currency name) 1. EDIT (Editorial processes is the same as setting) 2.DELETE → CURRENCY EXCHANGE RATE SETTING

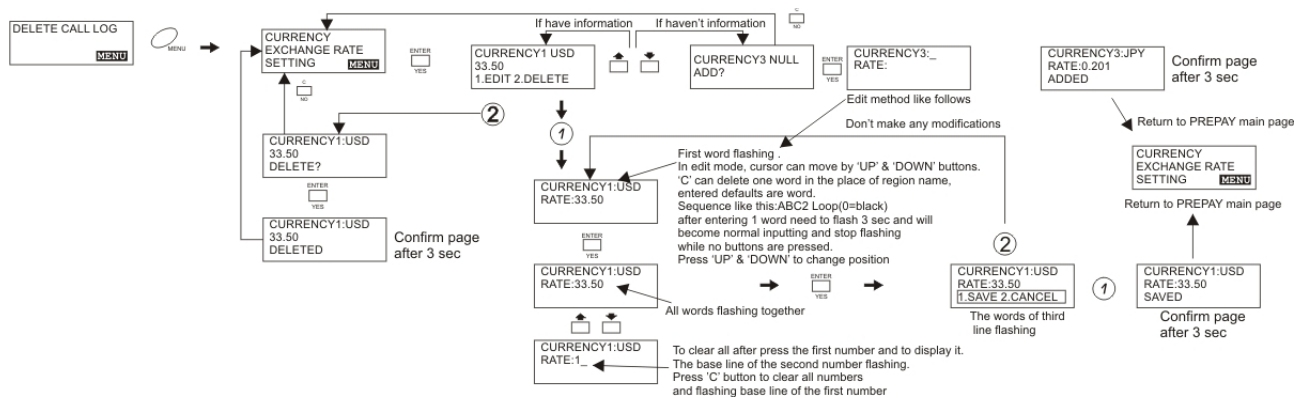

(5). SET MAX.CREDIT FOR POST PAY

CURRENCY EXCHANGE RATE SETTING → press MENU button → SET MAX.CREDIT FOR POST PAY → press ENTER button → MAX.CREDIT FOR POST PAY USA – (cursor) → Set Max credit → press ENTER button → After setting done → MAX. CREDIT FOR POST PAY YTL502 SET OK → Confirm setting with flashing 3 seconds → SET MAX.CREDIT FOR POST PAY

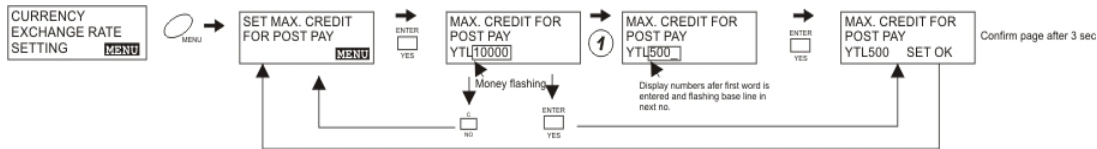

(6). SET RATE UNIT

SET MAX.CREDIT FOR POST PAY → press MENU button → SET RATE UNIT → press ENTER button → MODIFY UNIT FOR THE COUNT CHARGE 1U = HOW MUCH RMB (local currency name) → Enter content according to cursor position → after setting done → press ENTER button → Confirm setting with flashing 3 seconds → SET RATE UNIT

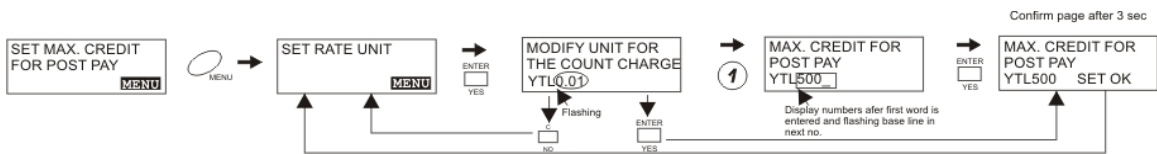

(7). SET DATE/TIME

SET RATE UNIT → press MENU button → SET DATE/TIME → press ENTER button → DATE/TIME YY/MM/DD HH : MM 00/01/01 12 : 00, cursor flashing to remind input contents → If set contents like 06 year 6 month 6 day 12 o'clock → DATE/TIME YY/MM/DD HH : MM 06/06/06 12 : 00) → After setting done → press ENTER button → press C/NO button can return last step → press ENTER button → Confirm setting with flashing 3 seconds → press C/NO button with 2 times → SET DATE/TIME

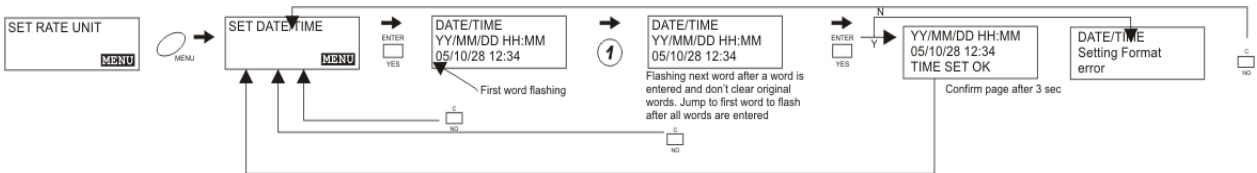

(8). SET DATE FORMAT

Format contents: Year 、 Month 、 Day

SET DATE/TIME → enter MENU button → SET DATE FORMAT → press ENTER button → 1.YY/MM/DD (year/month/day) 2.DDMMYY (day/month/year) 3. MM/DD/YY (month/day/year) → select 1/2/3 → DATE FORMAT YY/MM/DD / DDMMYY / MMDDYY SETUP OK → Confirm setting with flashing 3 seconds → SET DATE FORMAT

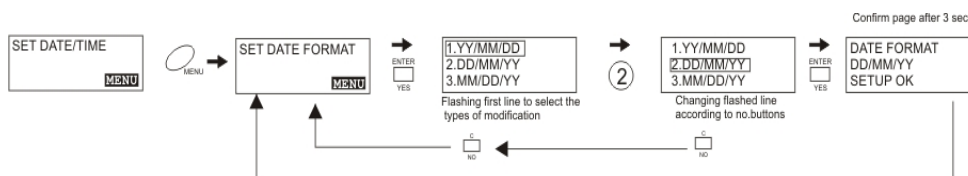

(9). SET TIME FORMAT

Time format : 12 Hours/24 Hours

SET DATE FORMAT → press MENU button → SET TIME FORMAT → press ENTER button → TIME FORMAT 1. 12HR (12 Hours) 2. 24HR (24 Hours) → select 1 or 2 → press ENTER button → TIME FORMAT 12HR/24HR SETUP OK → Confirm setting with flashing 3 seconds → SET TIME FORMAT

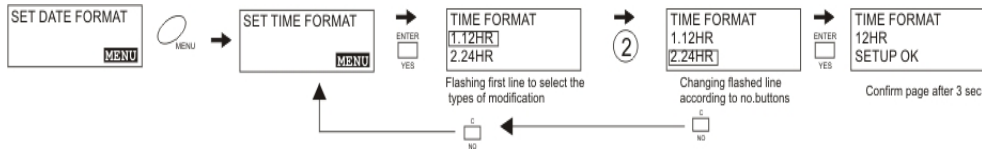

(10). CHANGE PASSWORD

SET TIME FORMAT → press MENU button → CHANGE PASSWORD → press ENTER button to enter password setting → NEW PASSWORD: (6–10 DIGITS) – (cursor flashing) → enter password : 111111 → press ENTER button → TYPE AGAIN NEW PASSWORD : – (cursor flashing) → Restart to enter same password for confirmation : 111111 (if password is different form the first time entered will remind error via pressing ENTER button) → press ENTER button → Confirm setting with flashing 3 seconds → CHANGE PASSWORD

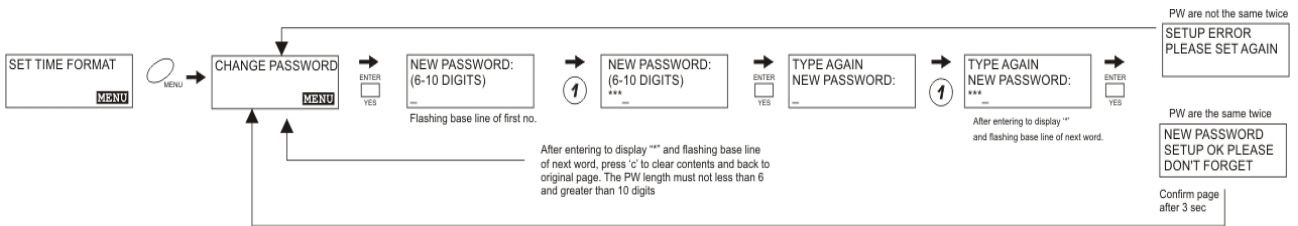

(11). PARAMETER SETTING (Parameter's setting for DIALER)

CHANGE PASSWORD → press MENU button → PARAMETER SETTING → press ENTER button → PARAM SETTING → Cursor flashing remind → Set method: (for ex: set 66 = 001) → enter 66 → enter 001*# (One beep to remind setting ok, if get 3 beeps that means setting failed need restart again) → after setting done → press C/NO button → PARAMETER SETTING (The contents of parameters please refer to Dialer specifications)

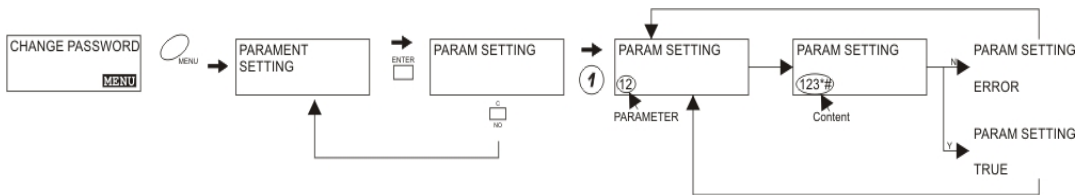

(12). ADJUST LCD CONTRAST

PARAMETER SETTING → press MENU button → ADJUST LCD CONTRAST → press ENTER button → LCD CONTRAST ADJUST .. → press UP and Down can adjust contract → press C/No button → ADJUST LCD CONTRAST

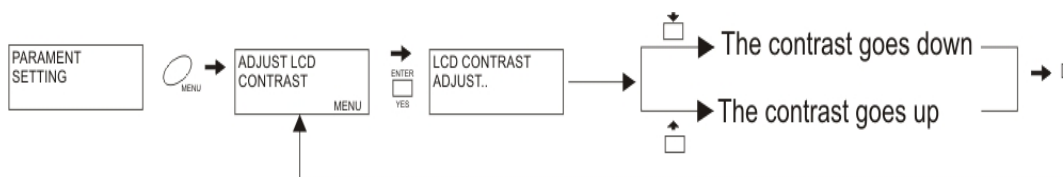

(13). START BILLING BY MODE

A. DTMF Application

ADJUST LCD CONTRAST → press MENU button → START BILLING BY MODE → press ENTER button → LCD display: START BILLING BY 1.DTMF 2.PTT → select 1.DTMF → START BILLING BY DTMF 1.ON 2.OFF → select 1.ON (Note: if select 2 means to disable DTMF mode) → START BY DTMF 1.A 2.B 3.C 4.D 5.ABCD 6.ABCD*# → If select 6.ABCD*# → START BY DTMF 6.ABCD*# SET OK → press ENTER button → START BILLING BY MODE

If activated codes set successful by DTMF mode, if set activated codes to 6.ABCD*#, then both on Post pay and Prepay Deposit mode to make phone call, once system received activated code any of them (A or B or C or D or * or #) can get through the other party and will start billing at once. If AX5000 system have not received any activated code yet, then the called party can only hear voice from the other party, but can not talk to the other party, because the other party can not hear at all under this circumstance.

B. PTT Application

ADJUST LCD CONTRAST → press MENU button → START BILLING BY MODE → press ENTER button → START BILLING BY 1.DTMF 2.PTT → select 2.PTT → START BY PTT 1.ON 2.OFF → select 1.ON (Note: if select 2 means to disable PTT mode) → START BY PTT PTT MODE SET OK → press ENTER button → START BILLING BY MODE

If PTT set successful, on Post and Prepay Deposit modes to make phone call, after phone numbers are dialed completely, then to press * button can get through with the other party and will start billing immediately. Under this circumstance, If the called party forget to press * button, then the called party only can hear the other party's voice, but can not talk to the other party, because the other party can not hear at all under this circumstance.

C. DTMF + PTT Application

If both DTMF and PTT modes are set, then billing way will be started according to DTMF or PTT.

For example: If DTMF set to ABCD*# and PTT set to ON, then once AX5000 system received any of the activated code(A or B or C or D or * or #) or press * button can be started immediately.

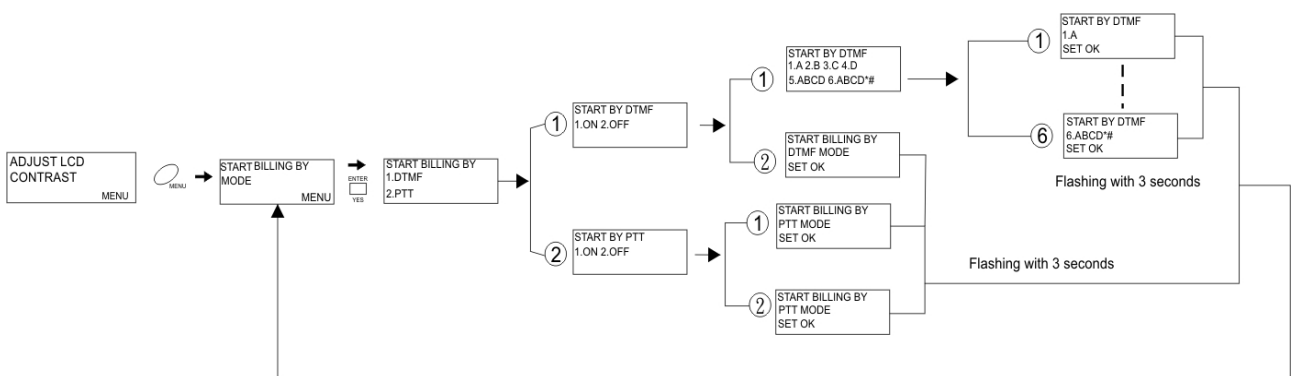

(14).TAKE OUT DATA TO FLASH CARD

START BILLING MODE → press MENU button → TAKE OUT DATA TO FLASH CARD → press ENTER button → TAKE OUT DATA TO FLASH CARD SURE? →

press ENTER button → TAKING OUT PLEASE WAIT → press ENTER button → TAKE OUT DATA SUCCESS! → Confirm setting with flashing 3 seconds → TAKE OUT DATA TO FLASH CARD

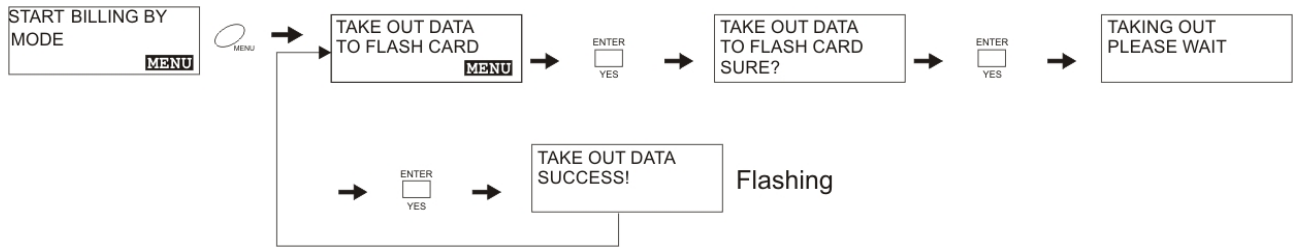

(15).. LOCAL CURRENCY NAME

TAKE OUT DATA TO FLASH CARD → press MENU button → LOCAL CURRENCY NAME → press ENTER button → YTL flashing → enter contents to instead of YTL (such as RMB) → flashing content → press ENTER button → Confirm setting with flashing 3 seconds → LOCAL CURRENCY NAME

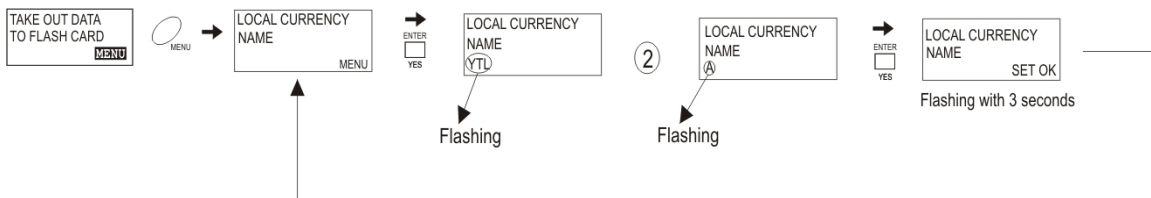

(16). EXIT OWNER MODE

LOCAL CURRENCY NAME → press MENU button → EXIT OWNER MODE → (if press MENU at this moment will still in owner mode to RATE MANEGEMENT) Press ENTER button will exit owner mode → SHOW CALL LOG

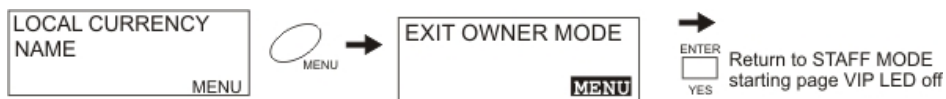

Section 7. Remote Update Introduction

AX5000 can be controlled by administrator via a special software on computer (LM4000), it can update parameters of Dialer and unit rate information, the most important that auto online and Caller ID online can be used to realize automatically update way to greatly facilitate user's management.

Section 8. Usage Warnings

1. On owner mode, once parameter 99 is cleared, then the activated codes from first to fifth path will be cleared completely (Please note this functionality is different from Dialer);
2. If the DC power and inside battery disconnect to AX5000, then the time and date will be reset to 00 : 01 01 – 01, if the low battery caused disconnecting, please change a new battery for using;
3. If the power disconnect AX5000 so frequently will result in the time delayed with current clock time, because system will take about 3 seconds to reset while restarting power-up, so under exactly time circumstances, please restart to set time again;
4. Whatever there have battery inside device or not, once the programming done, the time and date will recover to factory default: 12 : 00 01/01
5. If the IC card is removed on setting mode, then to insert IC card immediately that also can return IC card mode under inquiry mode;
6. The switch for connecting battery can not be used under AX5000 powered by DC power, it is only used for programming to update program status;
7. Remote update includes :
 - A. CALL IN WITH VOICE
 - B. CALL HOME
 - C. CALL OUT WITH VOICE
 - D. CALL OUT WITH RING OFF

Reminder:

For the sake of avoiding conflict between making phone call and parameter updating, we suggest don't to do Call home, Call out with voice and Call out with ring off on Post pay and Prepay Deposit modes; As for Call in with voice, it must be executed on Post Pay and Prepay Deposit modes.